

**PU PANEL**



PU F-METAL & T-METAL



PU MOSAIC PANEL

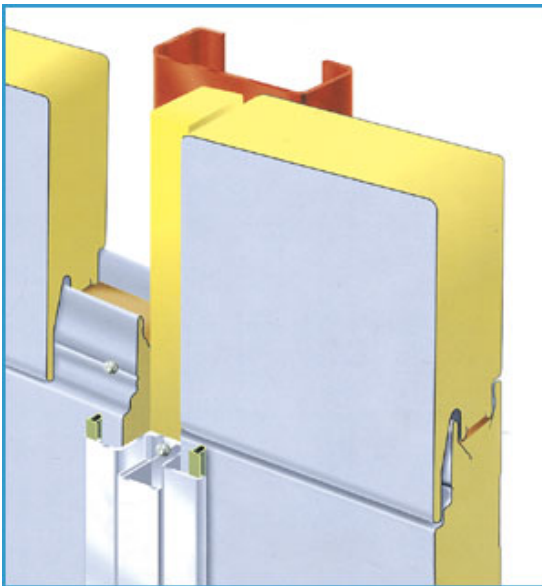

F-METAL JOINT

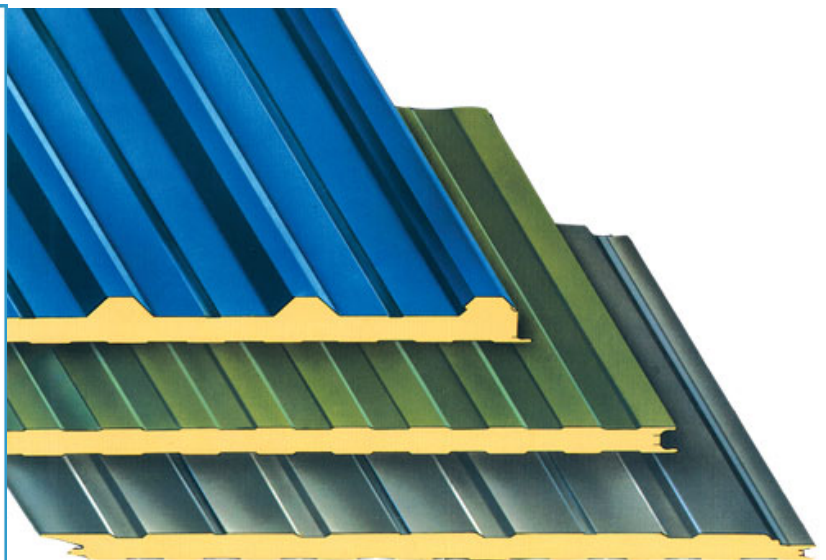

Roof and Wall

## F - METAL

900 (600, 750, 1000)

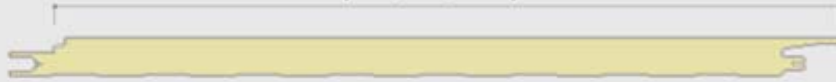

## T - METAL

900 (600, 750, 1000)



### WALL PANEL

UDS

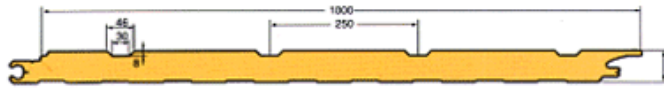

### 조립단면도

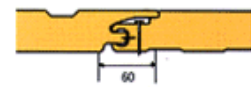

USS



UFF

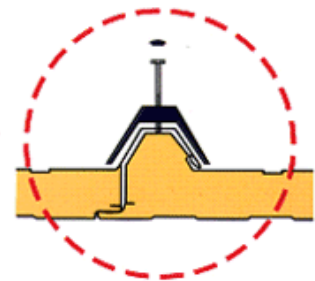

### ROOF PANEL

URS

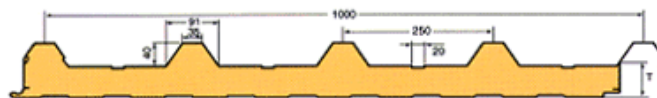

URE  
(E·P·D·M)

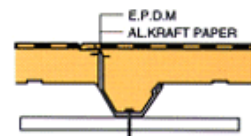
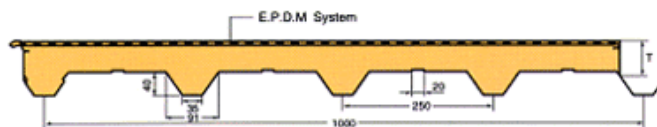

URM  
(membrane)

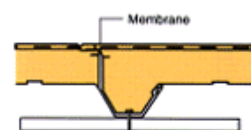
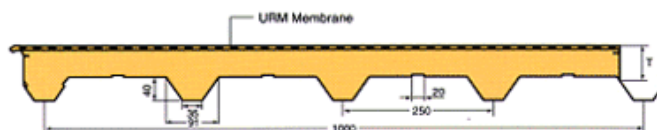

**GLASSWOOL PANEL**

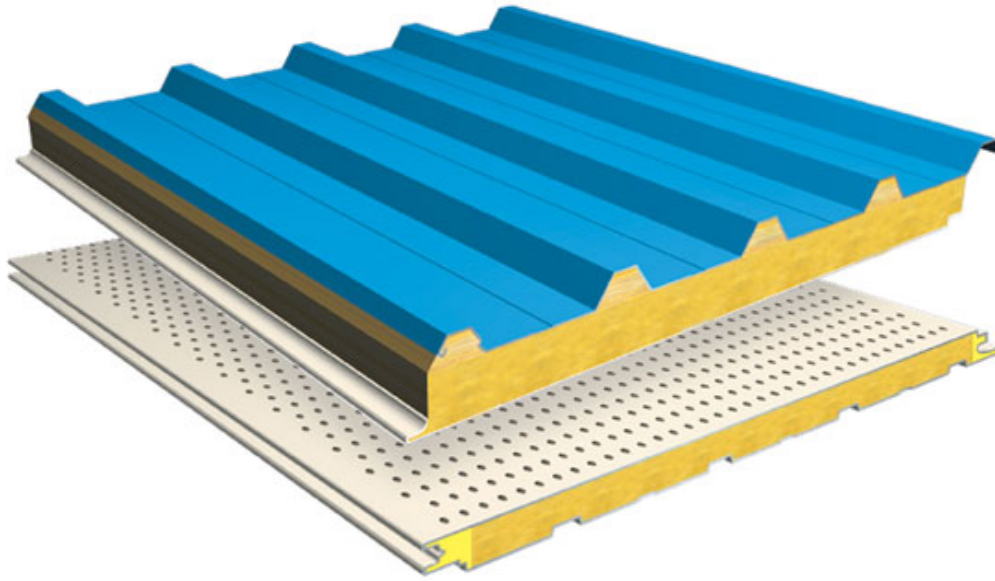

GRS Roof Panel & H-GDS(Sound Absorption Panel)



Glasswool Wall Panel

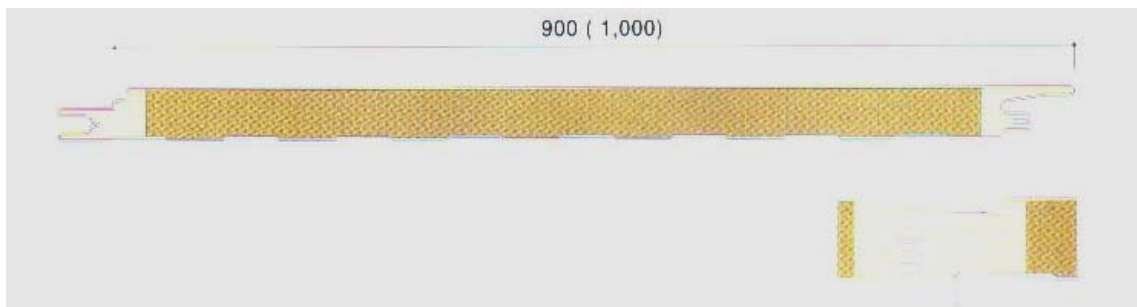

GF-METAL SHAPE

**MINEALWOOL PANEL(Rockwool)**

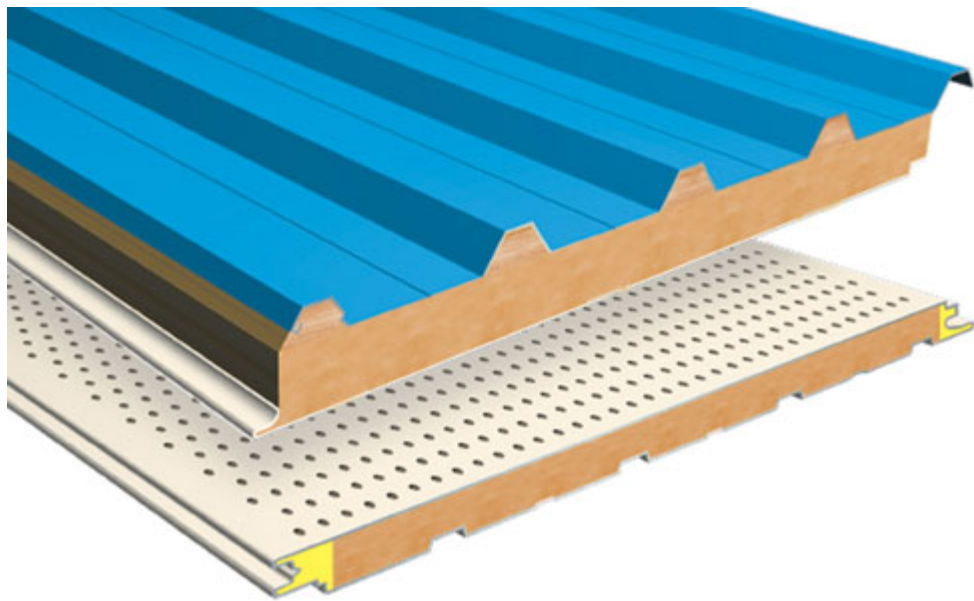

MRS Roof Panel & H-MDS(Sound Absorption Panel)

